

Name: _____ Date: _____

Calculate Perimeter

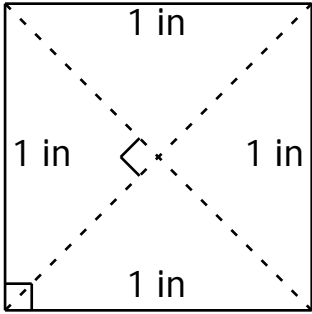

P = _____

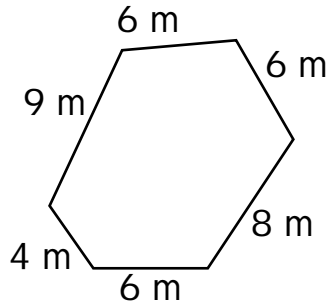

P = _____

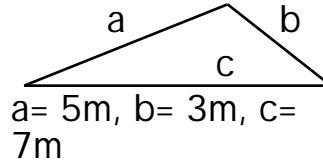

P = _____

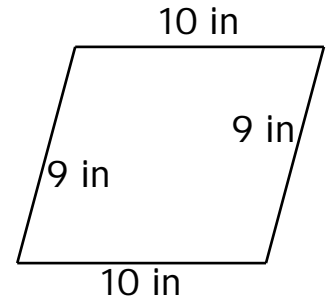

P = _____

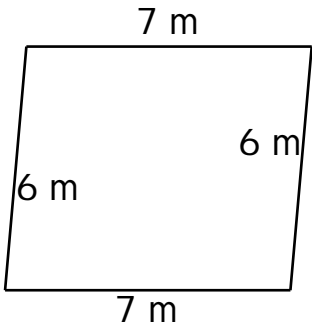

P = _____

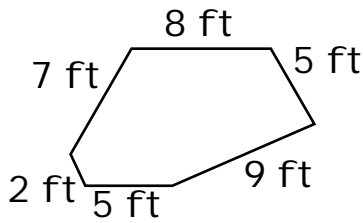

P = _____

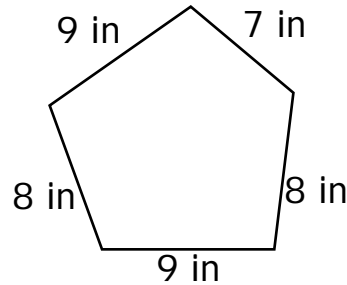

P = _____

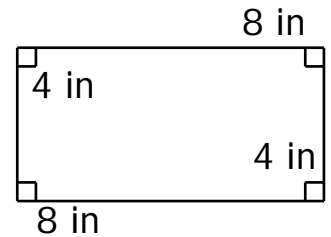

P = _____

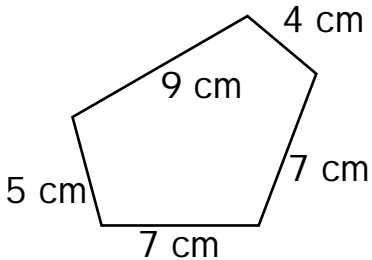

P = _____

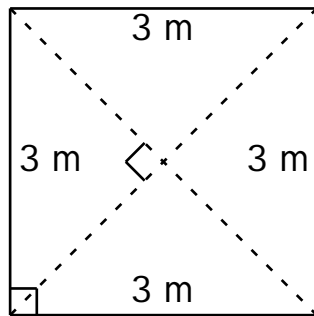

P = _____

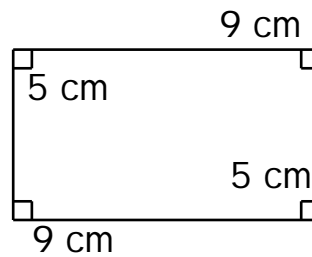

P = _____

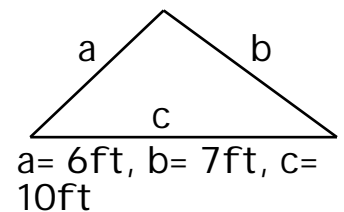

P = _____

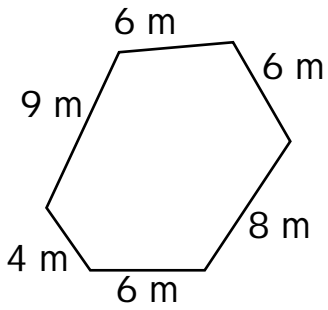

P = 39 m

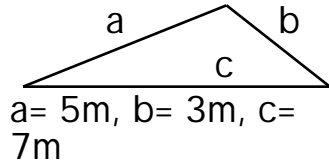

P = 15 m

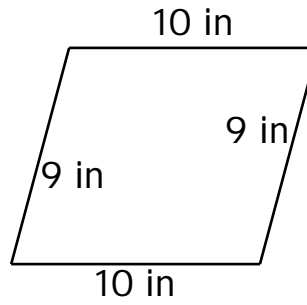

P = 38 in

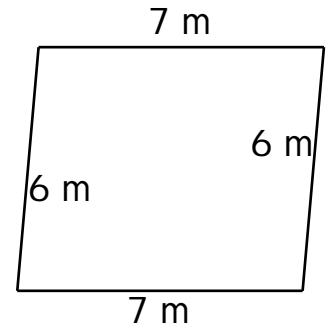

P = 26 m

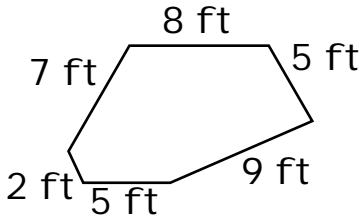

P = 36 ft

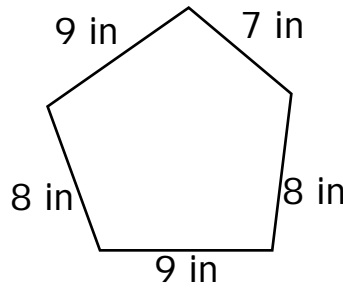

P = 41 in

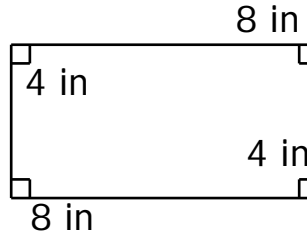

P = 24 in

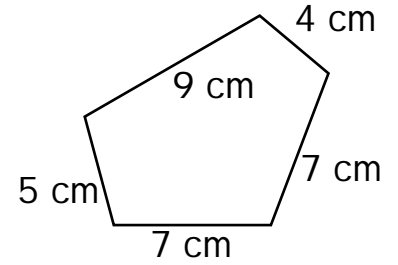

P = 32 cm

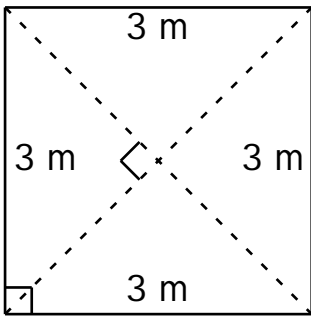

P = 12 m

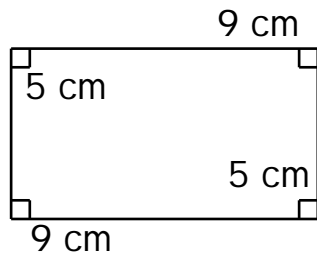

P = 28 cm

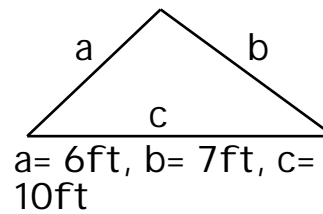

P = 23 ft

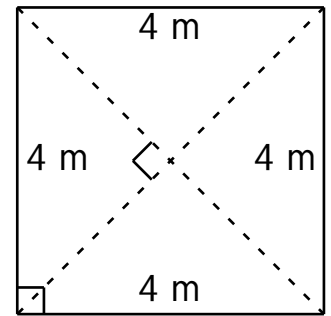

P = 16 m